

Article	Description
---------	-------------

AS-10	Adhesive sheets 210mm x 140mm (10 sheets)
-------	---



Standard delivered, 1 sheet

AS-EGX-350	Adhesive rubber sheet 305mm x 230mm
------------	-------------------------------------

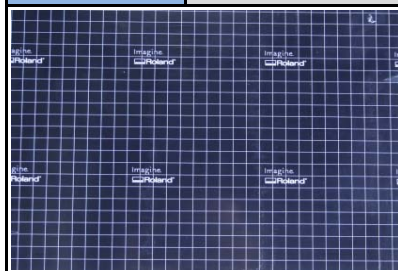

ZC-23-3	Collet (diameter 3mm)
---------	-----------------------

ZC-23-3175	Collet (diameter 3,175mm)
------------	---------------------------

ZC-23-4	Collet (diameter 4mm)
---------	-----------------------

ZC-23-6	Collet (diameter 6mm)
---------	-----------------------

ZC-23-6.35	Collet (diameter 6,35mm)
------------	--------------------------

ZC-23	Colletset (diameters 3mm, 4mm, 5mm & 6mm)
-------	---





ZC-E436	Holder collet (diameter 4,36mm)
---------	---------------------------------

21655108*	Holder collet (diameter 3,175mm)
-----------	----------------------------------

*= Standard delivered



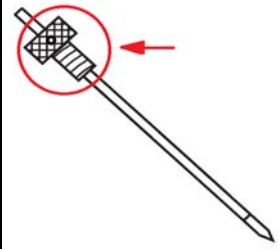

1000003391	Stepped holder collet (diameter 4,36mm)	Standard delivered
		

ZB-20	Burnishing attachment Ø 3,175mm	
		

ZSK-A2000*	Spindle knob Ø 3,175mm (brass)	*= Standard delivered
ZSK-A4000	Spindle knob Ø 4,36mm (brass)	
		

ZDN-200	Conical adapter for depth regulator	
		

1000003358	Straight adapter for depth regulator (standard with EGX-350)	Standard delivered
		

RWSTUDIO	R-wear Studio - Rhinestone design software
	

ZV-23C	Self centering vice for the positioning and fixation on the EGX-350. Loadable material using the jaws for nameplates: 152 mm (X) x 148 mm (Y) en 35 mm (H) Loadable material using the jaws for pens and tubular materials: 90 mm (X) x 146 mm (Y) en 20 mm (H) Compatible with EJ-FIVE-KIT.
--------	--



ZTT-35	T-slot table. Table size: 292mm(X) x 220mm(Y). 3 jaws included
--------	---



ZV-23A	Vacuum table. Table size: 292mm(X) x 220mm(Y). Vacuum pump is required
--------	---

22055299	Extra rubber sheet to put on the vacuum table.
----------	--



Extraction

D0242A8201	DustPro 50 EGX Range
------------	----------------------

A1030135	Replcement Filter Bag
----------	-----------------------



Vices

EV-QUICK-L	Vice for the fast positioning and fixation of material on the EGX-350. Delivered with a kit of 5 different jaws.
------------	---

EV-CENTRE-L	Self centering vice for the positioning and fixation of material on the EGX-350. Delivered with a kit of 5 different jaws.
-------------	---



EJ-FIVE-KIT	Kit of 5 different jaws.
-------------	--------------------------

EJ-FOUR-KIT	Kit of 4 different jaws. (= EJ-FIVE-KIT without the EJ-RULER jaw)
-------------	---



Jaws

EJ-MEDAL	These jaws enable engraving on notary seals, medallions, coasters, paperweights, watches, pendants and other round objects.
----------	---



EJ-PE-MEDAL	These jaws are similar to the normal metal jaws, but they're made out of PE in order to prevent damaging your precious objects.
--------------------	---



EJ-PIN	These jaws enable engraving on irregular-shaped and unique-sized items. Easy to modify for a special application.
---------------	---

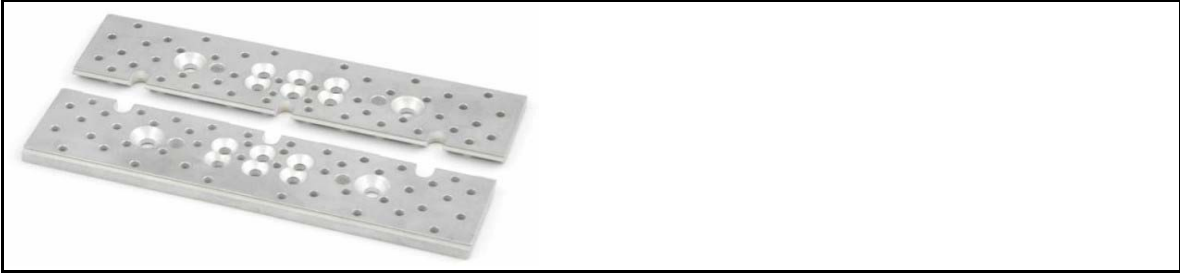

EJ-PEN	These jaws are used for holding pens. They have a slot for a pen clip on one side and a V-groove on the other edge.
---------------	---



EJ-RULER	These flat jaws secure small flat items, such as name badges with pin backs. Like most others, these jaws are made of aluminium. Aluminium hardly wears out, so the jaws and vices don't lose their compatibility.
-----------------	--



Engraving tools

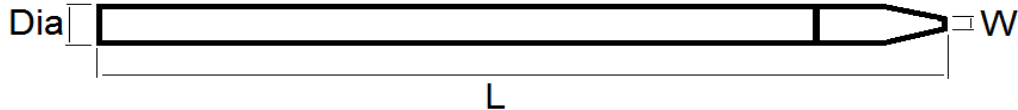

Conical engraving tools (for synthetic material)

*= Standard delivered

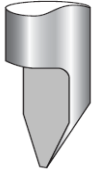
	Article code	Description
	ZEC-A2013	∅ 3,175 x 114 L x 0,13 W
	ZEC-A2025*	∅ 3,175 x 114 L x 0,25 W
	ZEC-A2051	∅ 3,175 x 114 L x 0,51 W
	ZEC-A2076	∅ 3,175 x 114 L x 0,76 W
ZEC-A4013	∅ 4,36 x 165 L x 0,13 W	
ZEC-A4025	∅ 4,36 x 165 L x 0,25 W	
ZEC-A4051	∅ 4,36 x 165 L x 0,51 W	
ZEC-A4076	∅ 4,36 x 165 L x 0,76 W	

Conical engraving tools (for light metals like brass & Aluminium)

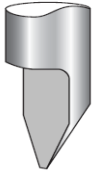
	Article code	Description
	ZEC-A2013BAL	∅ 3,175 x 114 L x 0,13 W
	ZEC-A2025BAL	∅ 3,175 x 114 L x 0,25 W
	ZEC-A4013BAL	∅ 4,36 x 165 L x 0,13 W
	ZEC-A4025BAL	∅ 4,36 x 165 L x 0,25 W

Flat engraving tools (for synthetic materials)

*= standard delivered

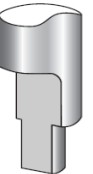
	Article code	Description
	ZEC-A2150	∅ 3,175 x 114 L x 1,52 W
	ZEC-A2190	∅ 3,175 x 114 L x 1,91 W
	ZEC-A2230	∅ 3,175 x 114 L x 2,29 W
	ZEC-A2320*	∅ 3,175 x 114 L x 3,175 W
	ZEC-A4150	∅ 4,36 x 165 L x 1,52 W
	ZEC-A4190	∅ 4,36 x 165 L x 1,91 W
	ZEC-A4230	∅ 4,36 x 165 L x 2,29 W
	ZEC-A4320	∅ 4,36 x 165 L x 3,175 W
	ZEC-A4380	∅ 4,36 x 165 L x 3,81 W
	ZEC-A4430	∅ 4,36 x 165 L x 4,34 W

Quarter-round engraving tools (for synthetic materials)

	Article code	Description
	ZEC-A2013-QR	∅ 3,175 x 114 L x 0,13 W
	ZEC-A2025-QR	∅ 3,175 x 114 L x 0,25 W
	ZEC-A4013-QR	∅ 4,36 x 165 L x 0,13 W
	ZEC-A4025-QR	∅ 4,36 x 165 L x 0,25 W

Diamond scraper (non-rotating spindle)

	Article code	Description
	ZDC-A2000	∅ 3,175 x 110 L x 120° hoek (standaard)
	ZDC-A2000-90	∅ 3,175 x 110 L x 90° hoek
	ZDC-A4000	∅ 4,36 x 178 L x 120° hoek

Diamond scraper (Rotating spindle)

	Article code	Description
	ZDC-A2000R	Ø 3,175 x 127 L x 0,5 W

Spiral flute engraving tools (for synthetic materials and metals)

	Article code	Description
	ZEC-CS1SF	Ø 3,175 x 110 L

Milling tools

Square end milling tools

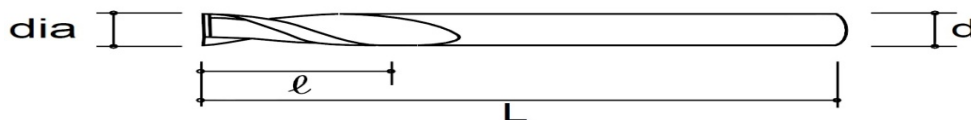

ZHS-100	High speed steel: Ø1 x 3(l) x 6(d) x 50(L) x 2NT
ZHS-200	High speed steel: Ø2 x 6(l) x 6(d) x 50(L) x 2NT
ZHS-300	High speed steel: Ø3 x 10(l) x 6(d) x 50(L) x 2NT
ZHS-400	High speed steel: Ø4 x 8(l) x 6(d) x 60(L) x 2NT
ZHS-500	High speed steel: Ø5 x 10(l) x 6(d) x 60(L) x 2NT
ZHS-600	High speed steel: Ø6 x 15(l) x 6(d) x 55(L) x 2NT
ZUS-500 *	Cemented Carbide: Ø5 x 25(l) x 6(d) x 60(L) x 2NT

* Until end of stock

Ball end milling tools

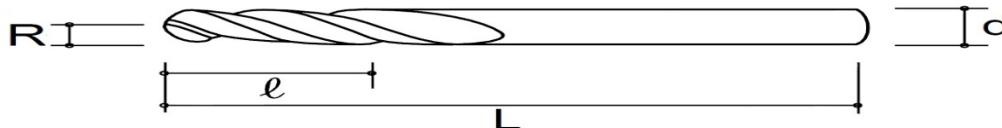

ZUB-250 *	Cemented Carbide: R2,5 x 20(l) x 5(d) x 65(L) x 2NT
ZCB-300	Cemented Carbide: R3,0 x 30(l) x 6(d) x 65(L) x 2NT

* Until end of stock

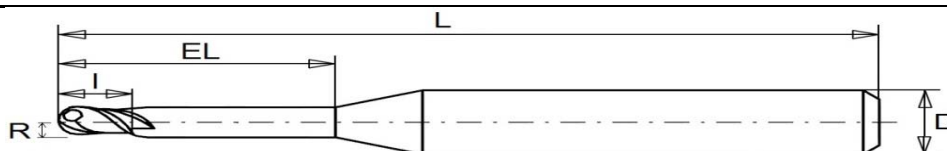

ZCB-40D	R0,4 x 2(l) x 10(EL) x 50(L) x 4(D) x 2NT
ZCB-50D	R0,5 x 2(l) x 12(EL) x 50(L) x 4(D) x 2NT
ZCB-100D	R1,0 x 10(l) x 16(EL) x 50(L) x 4(D) x 2NT